

recyKOIL

ESPIRAL DE PVC RECICLADO



MKIT





BINDING EXPERTS SINCE 1987

COLOR DISPONIBLE

para la fabricación de espiral 100% reciclado



DECLARACIÓN:

ESPIRAL 100% RECICLADO

Los espirales plásticos de encuadernación "RECYKOIL" de MKM están fabricados totalmente a partir de mermas y residuos generados en los procesos de fabricación.

SELLOS RECYKOIL



PASOS DE PERFORACIÓN

El paso de perforación es la distancia entre el centro de un agujero y el centro del siguiente, y determina la cantidad y distribución de perforaciones a lo largo del borde del documento.

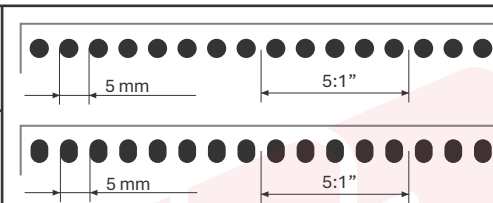
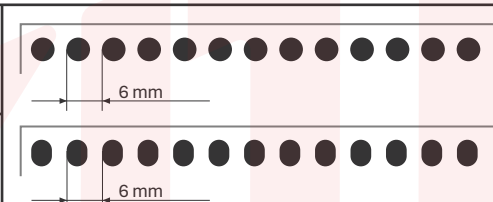
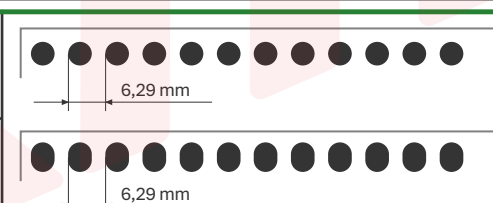
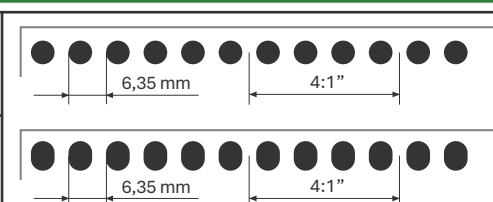
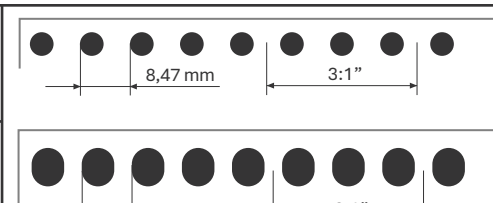







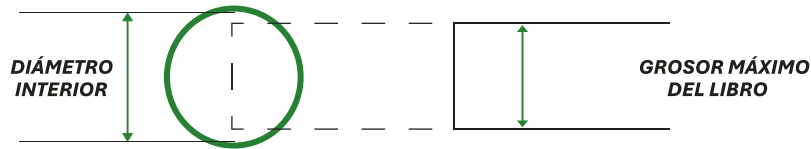

PASO	TALADROS		REPRESENTACIÓN GRÁFICA		
	NÚMERO	FORMA			
5,00 mm 5:1"	A5	41	REDONDO Ø 3,2 mm		EN DESUSO
	A4	59	-----		
	A3	83	OVALADO 3,2 x 4 mm		
6,00 mm	A5	34	REDONDO Ø 3,5 mm		EN DESUSO
	A4	49	-----		
	A3	69	OVALADO 3,2 x 4,5 mm		
6,29 mm 0,2475"	A5	33	REDONDO Ø 4 mm		RECOMENDADO
	A4	47	-----		
	A3	66	OVALADO 4 x 5 mm		
6,35 mm 4:1"	A5	32	REDONDO Ø 4 mm		COMÚN
	A4	46	-----		
	A3	65	OVALADO 4 x 5 mm		
8,47 mm 3:1"	A5	24	REDONDO Ø 4 mm		Ø GRANDES
	A4	34	-----		
	A3	49	OVALADO 5,5 x 6,5 mm		





Se recomienda el taladro ovalado sobre el redondo, ya que facilita la inserción de la espiral y el paso fluido de las páginas del cuaderno.

DIÁMETROS DE ESPIRAL

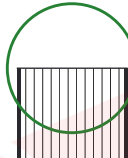
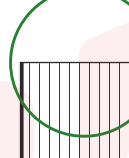

										
DIÁMETRO INTERIOR Ø	6 mm	8 mm	10 mm	12 mm	14 mm	16 mm	18 mm	20 mm	23 mm	25 mm
GROSOR MÁX. LIBRO	0,4 cm	0,6 cm	0,8 cm	1,1 cm	1,3 cm	1,4 cm	1,5 cm	1,6 cm	2,0 cm	2,2 cm
MÁXIMO DE HOJAS	35	55	75	95	115	135	150	170	200	220

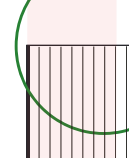
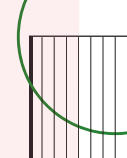
					
DIÁMETRO INTERIOR Ø	28 mm	30 mm	32 mm	35 mm	38 mm
GROSOR MÁX. LIBRO	2,5 cm	2,7 cm	2,9 cm	3,2 cm	3,5 cm
MÁXIMO DE HOJAS	250	265	275	295	315

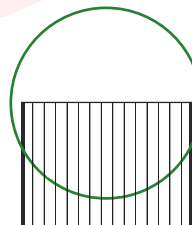
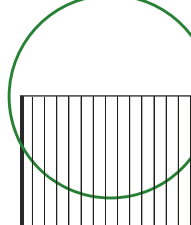
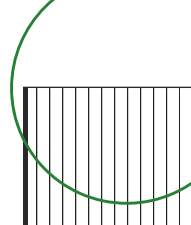
			
DIÁMETRO INTERIOR Ø	42 mm	45 mm	50 mm
GROSOR MÁX. LIBRO	3,7 cm	3,8 cm	4,4 cm
MÁXIMO DE HOJAS	350	370	420



BINDING EXPERTS SINCE 1987

LONGITUD DE ESPIRAL

Para calcular la longitud de la espiral, se toma la medida del lado del documento a encuadernar y se le añaden 3 cm adicionales (1,5 cm sobrantes en cada extremo de la espiral).

Longitud: mínima 17 cm - máxima 104 cm

A5 210 x 148,5 mm

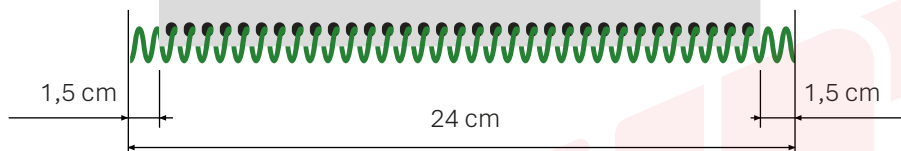

A4 297 x 210 mm



A3 420 x 297 mm

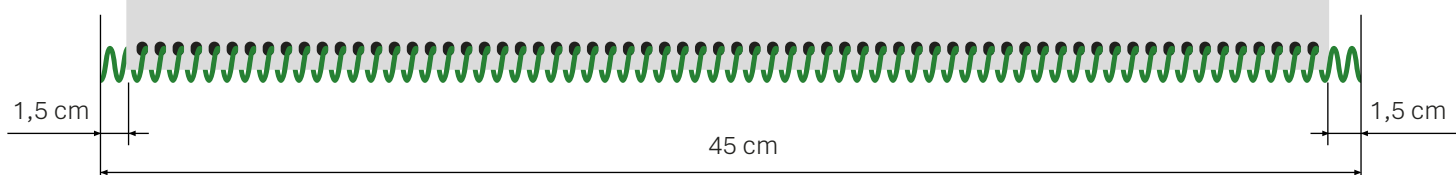



GROSOR DE HILO

Grosor: mínimo 1,80 mm - máximo 3,00 mm

Ø ESPIRAL	PASO 5 mm (5:1")	PASO 6 mm / 6,29 mm / 6,35 mm	PASO 8,47 mm (3:1")
6 mm	1,80	1,80	—
8 mm	1,80	1,80	2,40
10 mm	1,80	2,00	2,40
12 mm	1,80	2,00	2,40
14 mm	1,80	2,20	2,40
16 mm	2,00	2,20	2,60
18 mm	2,00	2,40	2,60
20 mm	2,00	2,40	2,60
23 mm	—	2,40	2,60
25 mm	—	2,60	2,60
28 mm	—	2,60	2,60
30 mm	—	2,60	2,60
32 mm	—	2,60	2,60
35 mm	—	2,60	2,80
38 mm	—	2,80	2,80
42 mm	—	2,80	2,80
45 mm	—	2,80	2,80
50 mm	—	2,80	2,80

— No recomendable.

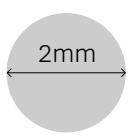
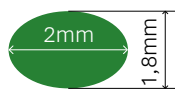
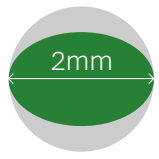
FILAMENTO REDONDO	FILAMENTO ELÍPTICO	COMPARACIÓN
 ✗ Dificulta la inserción ✗ Mayor gasto de material	 ✓ Facilita la inserción ✓ Ahorro de material	

ESPIRALES DIN A4

STANDARD PACK

Ø ESPIRAL	STANDARD PACK
FORMATO	A4
6 mm	100
8 mm	100
10 mm	100
12 mm	100
14 mm	100
16 mm	100
18 mm	100
20 mm	100
23 mm	100
25 mm	100
28 mm	50
30 mm	50
32 mm	50
35 mm	25
38 mm	25
42 mm	25
45 mm	25
50 mm	20



— Las mismas cantidades aplican para cualquier paso de perforación.

CANTIDADES POR CAJA

BIG PACK / SUPER PACK

Ø ESPIRAL	BIG PACK		SUPER PACK
FORMATO	A4	A5	A4
6 mm	1.200	1.650	3.000
8 mm	750	1.000	2.000
10 mm	500	700	1.100
12 mm	400	500	900
14 mm	300	400	575
16 mm	250	350	500
18 mm	200	250	500
20 mm	200	250	400
23 mm	175	300	500
25 mm	150	225	450
28 mm	125	200	325
30 mm	125	—	300
32 mm	100	—	250
35 mm	100	—	200
38 mm	75	—	200
42 mm	75	—	175
45 mm	50	—	150
50 mm	50	—	125



BIG PACK
(34 x 25 x 25 cm)



SUPER PACK
(55 x 28 x 30 cm)

The MKM logo is displayed in large, three-dimensional, metallic letters on the upper part of a building's facade. The building has a modern design with a large glass window reflecting the sky and trees. A green abstract graphic element is overlaid on the image, partially obscuring the logo and the building's facade.

MKM Comercial S.L.

P.I. Talluntxe I, c/A, nave 8

31110 NOÁIN (Navarra)

Tel. 948249944 - mkm@mkm.es



www.mkm.es



BINDING EXPERTS SINCE 1987

GUÍA DE PASOS DE PERFORACIÓN

PASOS DE ESPIRAL

ESCALA 1:1,5	
LEYENDA	
	Cada 10 punzones
	Anular punzón
	No anular punzón
	Ajuste no necesario
	Puede necesitar ajustes
	Ajuste y corte necesarios

NÚMERO DE PUNZONES					
PASOS DE PERFORACIÓN	TAMAÑO / FORMA * DEL TALADRO		A5	A4	A3
5 mm (5:1")		3,2 x 4 mm	42	60	85
6 mm		3,5 x 4,5 mm	34	49	69
6,29 mm (0,2475")		4 x 5 mm	33	47	61
6,35 mm (4:1")		4 x 5 mm	32	46	65
8,47 mm (3:1")		5,5 x 6,5 mm	24	34	49

297 x 420 mm

A3

FORMA DE PERFORADO	
FORMA DEL HILO DE PVC	

